

The Biotechnology Education Company®

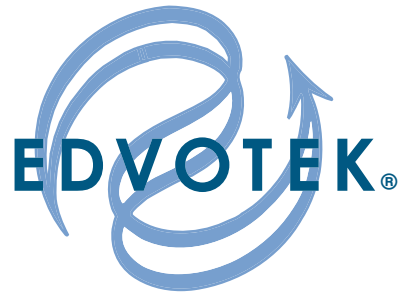

Principles and Practice of Agarose Gel Electrophoresis

101
EDVO-Kit #

Storage: Store the entire experiment at room temperature

EXPERIMENT OBJECTIVE:

The objective of this experiment is to develop a basic understanding of electrophoretic theory, and gain "hands-on" familiarity with the procedures involved in agarose gel electrophoresis to separate biological molecules.

All components are intended for educational research only. They are not to be used for diagnostic or drug purposes, nor administered to or consumed by humans or animals.

The Biotechnology Education Company® • 1-800-EDVOTEK • www.edvotek.com

Table of Contents

| | Page |
|--|------|
| Experiment Components | 3 |
| Experiment Requirements | 3 |
| Background Information | |
| Agarose Gel Electrophoresis | 4 |
| About Electrophoresis Equipment | 8 |
| Experiment Procedures | |
| Experiment Overview | 12 |
| Agarose Gel Preparation | 13 |
| Sample Delivery (Gel Loading) | 17 |
| Conducting Agarose Gel Electrophoresis | 19 |
| Experiment Results and Study Questions | 22 |
| Instructor's Guidelines | |
| Notes to the Instructor | 23 |
| Pre-Lab Preparations | 25 |
| Batch Agarose Gel Preparation | 28 |
| Experiment Results and Analysis | 29 |
| Study Questions and Answers | 30 |
| Material Safety Data Sheets | 31 |

EDVOTEK, The Biotechnology Education Company are registered trademarks of EDVOTEK, Inc. UltraSpec-Agarose is a trademark of EDVOTEK, Inc.



Experiment Components

ELECTROPHORESIS SAMPLES

- Ready-to-Load™ Dye samples
 - A Orange
 - B Purple
 - C Red
 - D Blue 1
 - E Dye Mixture
 - F Blue Dye Mixture (Blue 1 + Blue 2)

Storage:
Store entire experiment
at room temperature

REAGENTS & SUPPLIES:

- Practice Gel Loading Solution
- UltraSpec-Agarose™ powder
- Concentrated electrophoresis buffer
- 1 ml pipet
- 100 ml graduated cylinder (packaging for samples)
- Microtipped Transfer Pipets

THIS EXPERIMENT DOES NOT CONTAIN HUMAN DNA.

Requirements

- Horizontal gel electrophoresis apparatus
- D.C. power supply
- Automatic micropipets with tips
- Balance
- Microwave, hot plate or burner
- Pipet pumps or bulbs
- 250 ml flasks or beakers
- Hot gloves, vinyl gloves and safety goggles
- DNA visualization system (white light)
- Distilled or deionized water

All components are intended for educational research only. They are not to be used for diagnostic or drug purposes, nor administered to or consumed by humans or animals.

EDVOTEK - The Biotechnology Education Company®
1-800-EDVOTEK • www.edvotek.com
24-hour FAX: (301) 340-0582 • email: edvotek@aol.com

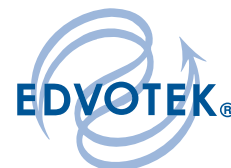

EVT 008114K

Agarose Gel Electrophoresis

Agarose gel electrophoresis is a widely used procedure in various areas of biotechnology. This simple, but precise, analytical procedure is used in research, biomedical and forensic laboratories. Of the various types of electrophoresis, agarose gel electrophoresis is one of the most common and widely used methods. It is a powerful separation method frequently used to analyze DNA fragments generated by restriction enzymes, and it is a convenient analytical method for determining the size of DNA molecules in the range of 500 to 30,000 base pairs. It can also be used to separate other charged biomolecules such as dyes, RNA and proteins.

The centerpiece and "workhorse" of agarose gel electrophoresis is the horizontal gel electrophoresis apparatus. There are many types of electrophoresis units, but the horizontal electrophoresis unit is the most commonly used unit for separating DNA molecules on agarose gels. Other types, such as protein (or vertical) electrophoresis, may utilize an apparatus which is shaped differently and utilizes polyacrylamide gels. The horizontal electrophoresis apparatus is essentially a sophisticated rectangular-shaped "box" with electrodes at each end. All EDVOTEK electrophoresis units, as well as all units found in research laboratories, contain platinum electrodes because of platinum's superior electrical conductivity and permanency. Because platinum electrodes are both expensive and fragile, care should be taken when handling electrophoresis equipment.

The separation medium is a gel made from agarose, which is a polysaccharide derivative of agar. Originating from seaweed, agarose is highly purified to remove impurities and charge. It is derived from the same seaweed as bacterial agar used in microbiology, as well as a food product called agar agar, which is used to prepare a gelatin-like dessert in Asian cuisine. Because agarose comes from the same source as the food product agar agar, it is a non-toxic substance. However, the gel contains buffer for conductivity, and as with any laboratory materials, it should not be eaten.

In EDVOTEK experiments, the agarose is mixed with hydrocolloids which makes the gel clearer, more resilient and less prone to breakage. This resulting mixture, called UltraSpec Agarose™, is prepared and used in the same manner as regular agarose, but with superior results. UltraSpec-Agarose™ is particularly well-suited for separating DNA molecules in the range of 500 to 30,000 base pairs. Gels cast with UltraSpec-Agarose™ are



Duplication of this document, in conjunction with use of accompanying reagents, is permitted for classroom/laboratory use only. This document, or any part, may not be reproduced or distributed for any other purpose without the written consent of EDVOTEK, Inc. Copyright © 1994, 1997, 1998, 1999, 2003 EDVOTEK, Inc., all rights reserved. EVT 008114K

Agarose Gel Electrophoresis

sturdier and more resilient, and consequently are less prone to breakage than conventional agarose. The enhanced resolving power and translucent quality of UltraSpec-Agarose™ results in greater visual clarity and definition of separated DNA fragments after staining.

The gel is made by dissolving agarose powder in boiling buffer solution. The solution is then cooled to approximately 55°C and poured into a casting tray which serves as a mold. A well-former template (often called a comb) is placed across the end of the casting tray to form wells when the gel solution solidifies.

After the gel solidifies, the gel is submerged in a buffer-filled electrophoresis chamber which contains a positive electrode at one end, and a negative electrode at the other. Samples are prepared for electrophoresis by mixing them with components, such as glycerol or sucrose, that will give the sample density. This makes the samples sink through the buffer and remain in the wells. These samples are delivered to the sample wells with a micropipet or transfer pipet.

A Direct Current (D.C.) power source is connected to the electrophoresis apparatus and electrical current is applied. Charged molecules in the sample enter the gel through the walls of the wells. Molecules having a net negative charge migrate towards the positive electrode (anode)

while net positively charged molecules migrate towards the negative electrode (cathode).

Within a range, the higher the applied voltage, the faster the samples migrate. The buffer serves as a conductor of electricity and to control the pH, which is important to the charge and stability of biological molecules. Since DNA has a strong negative charge at neutral pH, it migrates through the gel towards the positive electrode during electrophoresis.

If electrophoresis is conducted using dye samples, the migration of the various colored molecules can be visualized directly in the gel during electrophoresis and do not require staining. Because of the small size of the dye molecules, electrophoresis is fairly rapid. However,

the small size of the dye molecules also makes them susceptible to diffusion out of the gel. Thus, the results of dye electrophoresis experiments must be viewed immediately when the separation is complete. The gels cannot be saved.

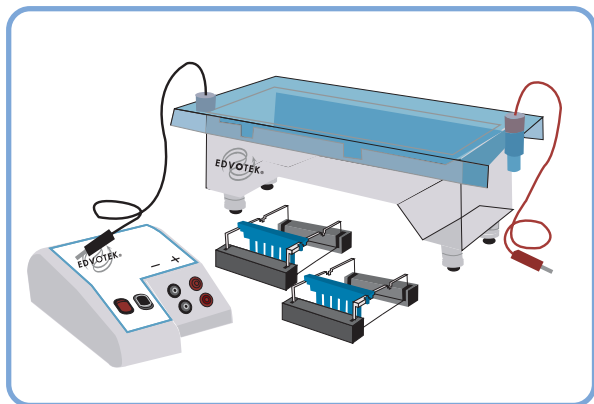

Agarose Gel Electrophoresis

On the other hand, gels separating DNA require staining in order to be visualized. Although DNA samples that are prepared for electrophoresis typically appear bluish-purple, the DNA itself does not have color. The color comes from a dye in a gel loading solution that is added at the end of typical DNA reactions, such as restriction enzyme digestion, or amplification by polymerase chain reaction. The gel loading solution stops the reaction. It also contains glycerol, which provides density to the sample so it will sink into the well during gel loading. The bluish-purple dye allows for visual tracking of sample migration during the electrophoresis. In general, most DNA samples follow behind the tracking dye during electrophoresis. Thus, it is important that electrophoresis is terminated before the tracking dye runs off the end of the gel.

The most commonly used stains for visualizing DNA contain either ethidium bromide or methylene blue. Ethidium bromide is a mutagen and must be handled and disposed according to strict local and/or state guidelines. Visualization also requires a short wave ultraviolet light source (transilluminator). Stains containing methylene blue are considered safer than ethidium bromide, but should still be handled and disposed with care. EDVOTEK has developed a quick and easy method of staining DNA, which is safer and minimizes the disposal of chemical waste, called InstaStain®.

Agarose gel electrophoresis possesses great resolving power, yet is relatively simple and straightforward to perform. The agarose gel consists of microscopic pores that act as a molecular sieve which separates molecules based upon charge, size and shape. These characteristics, together with buffer conditions, gel concentrations and voltage, affect the mobility of molecules in gels.

The sieving properties of the agarose gel influence the rate at which a molecule migrates. The charge to mass ratio is the same for different sized DNA molecules. The reason for this is inherent in the structure of the molecule. The nucleotides in DNA are linked together by negatively charged phosphodiester groups. For **every** base pair (average molecular weight of approximately 660) there are two charged phosphate groups. Therefore, every charge is accompanied by approximately the same mass. The absolute amount of charge on the molecule is not a critical factor in the separation process.



Duplication of this document, in conjunction with use of accompanying reagents, is permitted for classroom/laboratory use only. This document, or any part, may not be reproduced or distributed for any other purpose without the written consent of EDVOTEK, Inc. Copyright © 1994, 1997, 1998, 1999, 2003 EDVOTEK, Inc., all rights reserved. EVT 008114K

Agarose Gel Electrophoresis

The separation occurs because smaller molecules pass through the pores of the gel more easily than larger ones, i.e., the gel is sensitive to the physical size of the molecule. If the size of two fragments are similar or identical, they will migrate together in the gel. If chromosomal DNA is cleaved many times, the wide range of fragments produced will appear as a smear after electrophoresis.

Molecules can have the same molecular weight and charge but different shapes, as in the case of plasmid DNAs. Molecules having a more compact shape (a sphere is more compact than a rod) can move more easily through the pores. The migration rate of linear fragments of DNA is inversely proportional to the \log_{10} of their size in base pairs. This means that the smaller the linear fragment, the faster it migrates through the gel.

Given two molecules of the same molecular weight and shape, the one with the greater amount of charge will migrate faster. In addition, different molecules can interact with agarose to varying degrees. Molecules that bind more strongly to the agarose will migrate more slowly.

The mobility of molecules during electrophoresis is also influenced by gel concentration, and the volume of the agarose gel solution depends upon the size of the casting tray. Higher percentage gels, as well as thicker gels, are sturdier and easier to handle. However, the mobility of molecules and staining (where applicable) will take longer because of the tighter matrix of the gel.

In EDVOTEK experiments, the most common agarose gel concentration for separating dyes or DNA fragments is 0.8%. However, some experiments require agarose gels with a higher percentage, such as 1% or 1.5%. Because of such variability, it is important to read experiment instructions carefully to ensure that the gel is prepared with the proper concentration and volume to maximize successful experimental results.

The fundamental procedures of agarose gel electrophoresis, including gel casting, sample loading and separation are covered in this experiment. The separation of the dyes will be clearly visible during the electrophoresis process, so staining is not required. In this experiment, several different dye samples will be separated by agarose gel electrophoresis and their rate and direction of migration will be observed. Dyes A (Orange), B (Purple), C (Red) and D (Blue) are all negatively charged at neutral pH. Dye E is a mixture of dyes. Dye F (blue mixture) contains a dye with a net positive charge.

About Electrophoresis Equipment

Numerous equipment models are available for conducting horizontal agarose gel electrophoresis. The instructions in this document specifically address the use of EDVOTEK electrophoresis equipment, but can be adapted to equipment made by other manufacturers.

Familiarize yourself with the equipment you will be using before starting any experiment.

The equipment requirements for conducting agarose gel electrophoresis start with three basic items:

- 1) Horizontal gel electrophoresis apparatus
- 2) Direct Current (D.C.) power source
- 3) Sample delivery instrument (automatic micropipet)

Dye electrophoresis experiments do not require additional equipment, although a visible light source (light box) will enhance visualization of the bands in the gel.

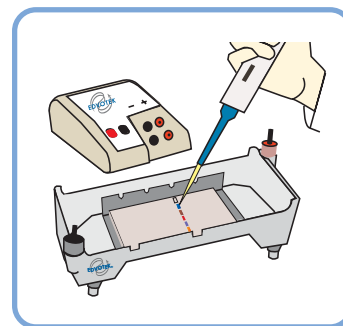

HORIZONTAL GEL ELECTROPHORESIS APPARATUS

The horizontal electrophoresis apparatus chamber contains electrodes at each end. All EDVOTEK electrophoresis units (and units used in research laboratories) contain platinum electrodes because of platinum's superior electrical conductivity and permanency. Because platinum electrodes are both expensive and fragile, care should be taken when handling electrophoresis equipment. By convention, the positive electrode (anode) is color-coded red, while the negative electrode (cathode) is black.

EDVOTEK electrophoresis apparatus models include removable gel casting trays with rubber end caps (dams) to close off the ends of the tray during gel casting. Other models may require the use of tape to close off the ends. Well-former templates (combs) form the wells into which samples are loaded for electrophoretic separation.

After the agarose gel is cast, the gel (on the tray) is placed in the buffer-filled apparatus chamber for sample loading and electrophoresis. During electrophoresis, molecules with a net negative charge will migrate towards the positive electrode, while molecules with a net positive charge will migrate towards the negative electrode. Because experiment #101 includes dye samples with a net negative or net positive charge, the experiment requires a gel with wells in the middle of the gel.

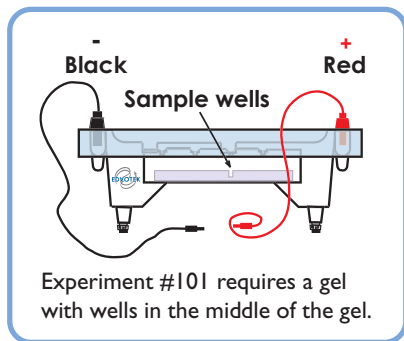

Duplication of this document, in conjunction with use of accompanying reagents, is permitted for classroom/laboratory use only. This document, or any part, may not be reproduced or distributed for any other purpose without the written consent of EDVOTEK, Inc. Copyright © 1994, 1997, 1998, 1999, 2003 EDVOTEK, Inc., all rights reserved. EVT 008114K

About Electrophoresis Equipment

GEL CASTING TRAYS

EDVOTEK injection-molded casting trays (also called gel beds) are available in two sizes, providing flexibility for a variety of experimental options. The rubber end caps fit tightly onto the ends of the gel casting tray. This feature eliminates the problem of leaking agarose solution associated with casting trays that require the ends of the gel bed to be closed with tape.

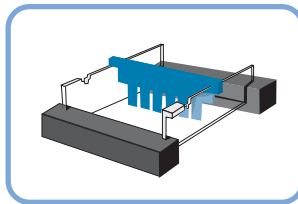

- **7 x 7 cm Gel Bed (short tray)**
(Cat. # 684: fits in EDVOTEK horizontal electrophoresis Models M6+, M12 and M36)

- **7 x 15 cm Gel Bed (long tray)**
(Cat. # 685: fits in EDVOTEK horizontal electrophoresis Models M12 and M36)

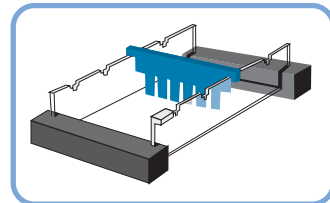

WELL-FORMER TEMPLATES (COMBS)

Two different well former templates (combs) are available for EDVOTEK injection-molded electrophoresis units (Models M6+, M12 and M36). The standard 6-tooth comb and the Double comb 8/10 provide flexibility for a variety of experimental options.

- **6-Tooth Comb**
(Cat. # 680)

Injection-molded polycarbonate comb for casting 6 wells that accommodate up to 38-40 μ l of sample

About Electrophoresis Equipment

- **Double Comb 8/10**
(Cat. # 683)

Injection-molded polycarbonate comb for increasing the number of wells per gel.
Capacity of wells:

- 8-tooth wells - up to 30 μ l
- 10-tooth wells - up to 20 μ l

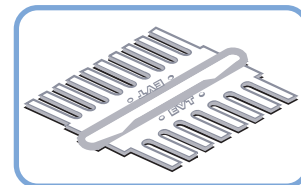

Comb size will impact the amount of sample that can be loaded into the sample wells. For equipment that is not manufactured by EDVOTEK, it may be necessary to pour thicker gels so the wells can accommodate enough sample for optimal results.

DIRECT CURRENT POWER SOURCE

Electrical current is applied to the electrophoresis apparatus using a Direct Current (D.C.) power source. There are numerous power sources available, with a variety of features. In general, whether you use constant voltage or variable voltage power sources, or even batteries, the higher the voltage applied the faster the samples migrate. However, the maximum amount of voltage that can be applied depends upon the design of the electrophoresis apparatus and should not exceed manufacturer's recommendations. Voltage that is too high can melt the agarose gel during electrophoresis and cause distortion of results. For EDVOTEK injection-molded electrophoresis units, maximum voltage should not exceed 125 volts.

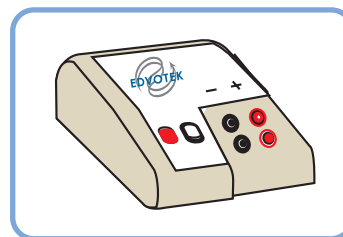

Duplication of this document, in conjunction with use of accompanying reagents, is permitted for classroom/laboratory use only. This document, or any part, may not be reproduced or distributed for any other purpose without the written consent of EDVOTEK, Inc. Copyright © 1994, 1997, 1998, 1999, 2003 EDVOTEK, Inc., all rights reserved.
EVT 008114K

About Electrophoresis Equipment

SAMPLE DELIVERY INSTRUMENTS

Although the variable automatic micropipet is the preferred instrument for delivering accurate, reproducible volumes of sample, other less expensive equipment alternatives include fixed volume micropipets or disposable transfer pipets.

Variable Automatic Micropipets:

An automatic micropipet is used to deliver accurate, reproducible volumes of sample.

- For the electrophoresis of dyes, load the well with 35-38 microliters of sample.
- Use a clean micropipet tip for loading each sample.

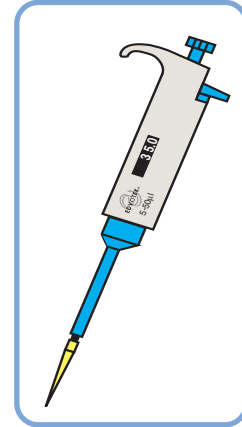

Fixed Volume Micropipets:

Accurate sample delivery can also be achieved using fixed volume micropipets. These types of micropipets are pre-set to a specific volume. Although the volume can not be changed, these types of micropipets operate similarly to the variable automatic micropipets. Most fixed volume pipets do not have ejector buttons, so the tips must be removed manually.

Transfer Pipets:

With EDVOTEK electrophoresis systems, an alternative sample delivery method can be used if you do not have automatic micropipets. Disposable plastic transfer pipets can be used, but they are not precise. Because their volumes cannot be accurately controlled, their use can result in significant sample waste.

To help control the delivery of small sample volumes with transfer pipets, gently squeeze the pipet stem, instead of the bulb. When using transfer pipets for sample delivery, load each sample well until it is full.

Clean by flushing the transfer pipet with distilled water several times after delivering each sample and before loading a new sample.

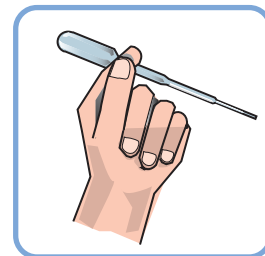

Experiment Overview

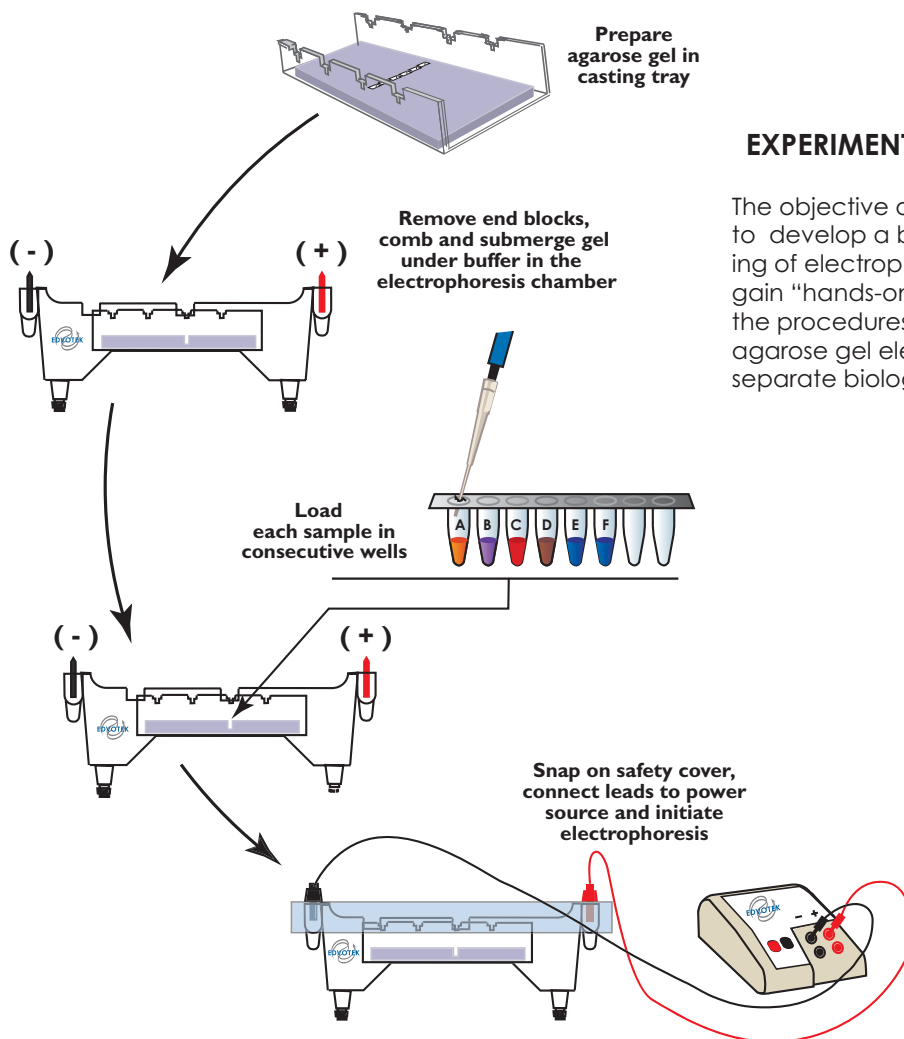
**EXPERIMENT OBJECTIVE:**

The objective of this experiment is to develop a basic understanding of electrophoretic theory, and gain "hands-on" familiarity with the procedures involved in agarose gel electrophoresis to separate biological molecules.

Expt. # 101 Gel Requirements

- Recommended gel tray size: 7 x 15 cm (long tray)
- Number of sample wells required: 6
- Placement of well-former template: middle set of notches
- Agarose gel concentration required: 0.8%



Duplication of this document, in conjunction with use of accompanying reagents, is permitted for classroom/ laboratory use only. This document, or any part, may not be reproduced or distributed for any other purpose without the written consent of EDVOTEK, Inc. Copyright © 1994, 1997, 1998, 1999, 2003 EDVOTEK, Inc., all rights reserved. EVT 008114K

Agarose Gel Preparation

LABORATORY SAFETY



Wear gloves and safety goggles

1. Gloves and goggles should be worn routinely as good laboratory practice.
2. Exercise extreme caution when working with equipment that is used in conjunction with the heating and/or melting of reagents.
3. DO NOT MOUTH PIPET REAGENTS - USE PIPET PUMPS.
4. Exercise caution when using any electrical equipment in the laboratory.
5. Always wash hands thoroughly with soap and water after handling reagents or biological materials in the laboratory.

PREPARING THE GEL BED

1. Close off the open ends of a clean and dry gel bed (casting tray) by using rubber dams or tape.
 - A. Using Rubber dams:
 - Place a rubber dam on each end of the bed. Make sure the rubber dam fits firmly in contact with the sides and bottom of the bed.
 - B. Taping with labeling or masking tape:
 - With 3/4 inch wide tape, extend the tape over the sides and bottom edge of the bed.
 - Fold the extended edges of the tape back onto the sides and bottom. Press contact points firmly to form a good seal.
2. Place a well-former template (comb) in the middle set of notches. Make sure the comb sits firmly and evenly across the bed.

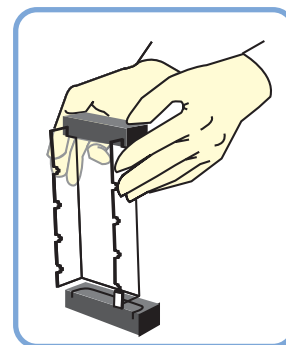

Important note:

Most experiments require that the well-former template be placed in notches at the end of the tray.

Expt. # 101 is unique - the well-former template is placed in set of notches in the **middle** of the tray.

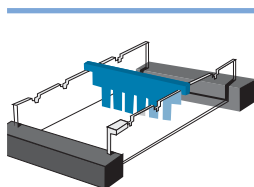

Agarose Gel Preparation

CASTING AGAROSE GELS

3. Use a 250 ml flask to prepare the gel solution. Add the following components to the flask as specified for your experiment (refer to Table A).
 - Buffer concentrate
 - Distilled water
 - Agarose powder

Table A Individual 0.8% UltraSpec-Agarose™ Gel Electrophoresis of Dyes

| Size of EDVOTEK Casting Tray (cm) | Amt of Agarose (gm) | + Concentrated Buffer (50x) (ml) | + Distilled Water (ml) | = Total Volume (ml) |
|-----------------------------------|---------------------|----------------------------------|------------------------|---------------------|
| 7 x 7 | 0.24 | 0.6 | 29.4 | 30 |
| 7 x 15 | 0.48 | 1.2 | 58.8 | 60 |

4. Swirl the mixture to disperse clumps of agarose powder.
5. With a marking pen, indicate the level of the solution volume on the outside of the flask.
6. Heat the mixture to dissolve the agarose powder. The final solution should appear clear (like water) without any undissolved particles.
 - A. Microwave method:
 - Cover the flask with plastic wrap to minimize evaporation.
 - Heat the mixture on High for 1 minute.
 - Swirl the mixture and heat on High in bursts of 25 seconds until all the agarose is completely dissolved.
 - B. Hot plate method:
 - Cover the flask with aluminum foil to prevent excess evaporation.
 - Heat the mixture to boiling over a burner with occasional swirling. Boil until all the agarose is completely dissolved.

Check the solution carefully. If you see "crystal" particles, the agarose is not completely dissolved.

At high altitudes, it is recommended to use a microwave oven to reach boiling temperatures.



Duplication of this document, in conjunction with use of accompanying reagents, is permitted for classroom/laboratory use only. This document, or any part, may not be reproduced or distributed for any other purpose without the written consent of EDVOTEK, Inc. Copyright © 1994, 1997, 1998, 1999, 2003 EDVOTEK, Inc., all rights reserved. EVT 008114K

Agarose Gel Preparation

- Cool the agarose solution to 55°C with careful swirling to promote even dissipation of heat. If detectable evaporation has occurred, add distilled water to bring the solution up to the original volume as marked on the flask in step 5.

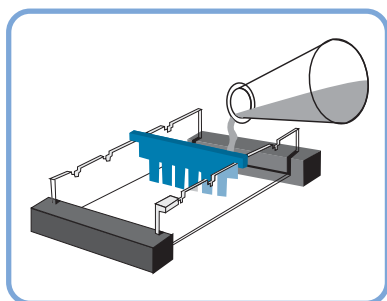

Cool the agarose to 55°C

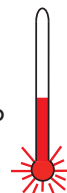

DO NOT POUR BOILING HOT AGAROSE INTO THE GEL BED.

Hot agarose solution may irreversibly warp the bed.

After the gel is cooled to 55°C:

If you are using rubber dams, go to step 9.
If you are using tape, continue with step 8.

- Seal the interface of the gel bed and tape to prevent the agarose solution from leaking.
 - Use a transfer pipet to deposit a small amount of cooled agarose to both inside ends of the bed.
 - Wait approximately 1 minute for the agarose to solidify.
- Pour the cooled agarose solution into the bed. Make sure the bed is on a level surface.
- Allow the gel to completely solidify. It will become firm and cool to the touch after approximately 20 minutes.

Agarose Gel Preparation

PREPARING THE GEL FOR ELECTROPHORESIS

- After the gel is completely solidified, carefully and slowly remove the rubber dams or tape from the gel bed.

Be especially careful not to damage or tear the gel wells when removing the rubber dams. A thin plastic knife, spatula or pipet tip can be inserted between the gel and the dams to break possible surface tension.

- Remove the comb by slowly pulling straight up. Do this carefully and evenly to prevent tearing the sample wells.
- Place the gel (on its bed) into the electrophoresis chamber, properly oriented, centered and level on the platform.
- Fill the electrophoresis apparatus chamber with the required volume of diluted buffer for the specific unit you are using (see guidelines in Table B).

For DNA analysis, the same EDVOTEK 50x Electrophoresis Buffer is used for preparing both the agarose gel buffer and the chamber buffer. The formula for diluting EDVOTEK (50x) concentrated buffer is 1 volume of buffer concentrate to every 49 volumes of distilled or deionized water.

The electrophoresis (chamber) buffer recommended is Tris-acetate-EDTA (20 mM Tris, 6 mM sodium acetate, 1 mM disodium ethylenediamine tetraacetic acid) pH 7.8. Prepare the buffer as required for your electrophoresis apparatus.

Table B Dilution of Electrophoresis (Chamber) Buffer

| EDVOTEK Model # | Concentrated Buffer (50x) (ml) | + Distilled Water (ml) | = Total Volume (ml) |
|-----------------|--------------------------------|------------------------|---------------------|
| M6+ | 6 | 294 | 300 |
| M12 | 8 | 392 | 400 |
| M36 (blue) | 10 | 490 | 500 |
| M36 (clear) | 20 | 980 | 1000 |

- Make sure the gel is completely covered with buffer.
- Proceed to loading the samples and conducting electrophoresis.



Duplication of this document, in conjunction with use of accompanying reagents, is permitted for classroom/laboratory use only. This document, or any part, may not be reproduced or distributed for any other purpose without the written consent of EDVOTEK, Inc. Copyright © 1994, 1997, 1998, 1999, 2003 EDVOTEK, Inc., all rights reserved. EVT 008114K

Sample Delivery (Gel Loading)

PRACTICE GEL LOADING

Accurate sample delivery technique ensures the best possible gel results. Pipeting mistakes can cause the sample to become diluted with buffer, or cause damage to the wells with the pipet tip while loading the gel.

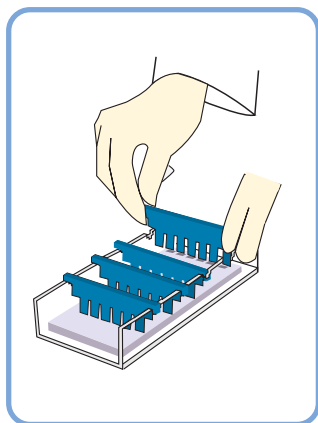

If you are unfamiliar with loading samples in agarose gels, it is recommended that you practice sample delivery techniques before conducting the actual experiment. EDVOTEK electrophoresis experiments contain a tube of practice gel loading solution for this purpose. Casting of a separate practice gel is highly recommended. One suggested activity is outlined below:

1. Cast a gel with the maximum number of wells possible.
2. After the gel solidifies, place it under buffer in an electrophoresis apparatus chamber.

Alternatively, your teacher may have cut the gel in sections between the rows of wells. Place a gel section with wells into a small, shallow tray and submerge it under buffer or water.

Note: The agarose gel is sometimes called a "submarine gel" because it is submerged under buffer for sample loading and electrophoretic separation.

3. Practice delivering the practice gel loading solution to the sample wells. Take care not to damage or puncture the wells with the pipet tip.
 - For electrophoresis of dyes, load the sample well with 35-38 microliters of sample.
 - If using transfer pipets for sample delivery, load each sample well until it is full.
4. If you need more practice, remove the practice gel loading solution by squirting buffer into the wells with a transfer pipet.
5. Replace the practice gel with a fresh gel for the actual experiment.

Note: If practice gel loading is performed in the electrophoresis chamber, the practice gel loading solution will become diluted in the buffer in the apparatus. A small amount of practice gel loading solution (filling up to 12 wells) will not interfere with the experiment, so it is not necessary to prepare fresh buffer.

See the following page for specific instructions regarding the operation of an automatic micropipet.

If you are using transfer pipets, gently squeeze the pipet stem, instead of the bulb to help control the delivery of small sample volumes.



Sample Delivery (Gel Loading)

SAMPLE DELIVERY WITH VARIABLE AUTOMATIC MICROPIPETETS:

1. Set the micropipet to the appropriate volume and place a clean tip on the micropipetor.

Press the top button down to the first stop, then immerse the tip into the sample.

2. Once the tip is immersed in the sample, release the button slowly to draw sample into the tip.

- 3A. Position the pipet tip over the well. Be careful not to puncture or damage the well with the pipet tip.

- 3B. Deliver the sample by pressing the button to the first stop - then empty the entire contents of the tip by pressing to the second stop.

- 3C. After delivering the sample, do not release the top button until the tip is out of the buffer.

4. Press the ejector button to discard the tip.

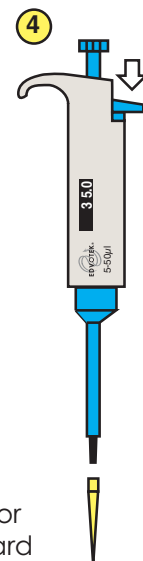
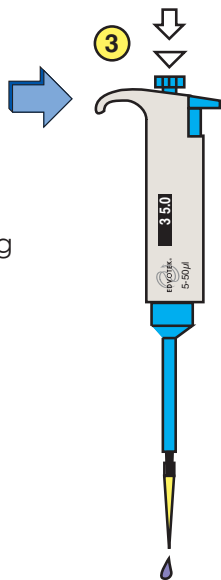
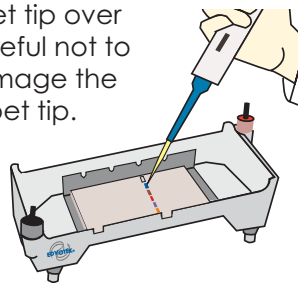
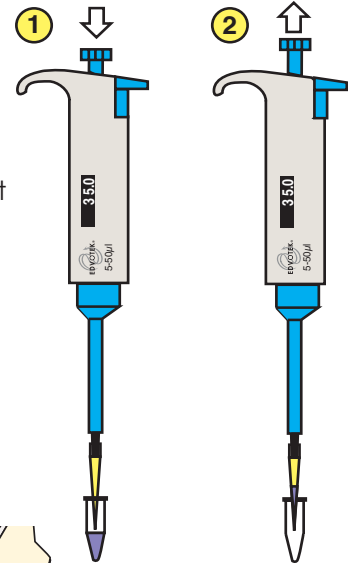

Duplication of this document, in conjunction with use of accompanying reagents, is permitted for classroom/ laboratory use only. This document, or any part, may not be reproduced or distributed for any other purpose without the written consent of EDVOTEK, Inc. Copyright © 1994, 1997, 1998, 1999, 2003 EDVOTEK, Inc., all rights reserved. EVT 008114K

Conducting Agarose Gel Electrophoresis

ELECTROPHORESIS SAMPLES

Samples in EDVOTEK Series 100 and Sci-On® Series electrophoresis experiments are packaged in one of two different formats:

- Pre-aliquoted QuickStrip™ connected tubes (new format)
or
- Individual 1.5 ml or 0.5 ml microtest tubes

Pre-aliquoted QuickStrip™ connected tubes

- Each set of QuickStrip™ connected tubes contains pre-aliquoted ready-to-load samples for one gel. A protective overlay covers the strip of QuickStrip™ sample tubes.
- Check the sample volume. Sometimes a small amount of sample will cling to the walls of the tubes. Make sure the entire volume of sample is at the the bottom of the tubes before starting to load the gel.
- Tap the overlay cover on top of the strip, or tap the entire QuickStrip™ on the table to make samples fall to the bottom of the tubes

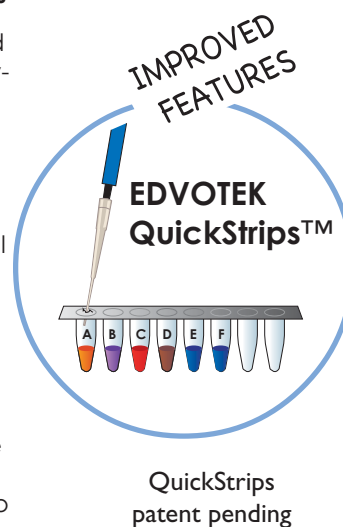

Individual 1.5 ml or 0.5 ml microtest tubes

- Your instructor may have aliquoted samples into a set of tubes for each lab group. Alternatively, you may be required to withdraw the appropriate amount of sample from the experiment stock tubes.
- Check the sample volume. Sometimes a small amount of sample will cling to the walls of the tubes. Make sure the entire volume of sample is at the the bottom of the tubes before starting to load the gel.
- Briefly centrifuge the sample tubes, or tap each tube on the tabletop to get all the sample to the bottom of the tube.

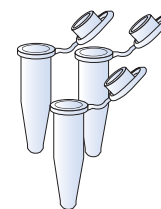

Conducting Agarose Gel Electrophoresis

QuickStrip™ Samples

Successful Pipetting with Micropipets

1. Do not disturb the samples in the QuickStrip™. Gently tap the QuickStrip™ tubes on the lab bench to ensure that samples are at the bottom of the tubes.

* If a sample becomes displaced while inserting the pipet tip in the tube, gently tap the QuickStrip™ on the lab bench to concentrate the sample to the bottom of the tube. With the pipet plunger depressed to the first stop, re-insert the tip into the sample and raise the micropipet plunger to withdraw the sample.

Delivering QuickStrip™ Samples with Transfer Pipets:

If using disposable transfer pipets for sample delivery, pierce the protective overlay with a paper clip before inserting the transfer pipet to withdraw the sample.

2. Stabilize the QuickStrip™ by firmly anchoring it on the lab bench.
3. Gently pierce the printed protective overlay with the pipet tip attached to a micropipet. Depress the micropipet plunger to the first stop before the tip is placed in contact with the sample.
4. With the pipet plunger depressed to the first stop, insert the tip into the sample.
5. Raise the plunger of the micropipet to withdraw the sample.
6. Load the sample into the appropriate well of the gel. Discard the tip.
7. Repeat steps 3-6 for each sample.

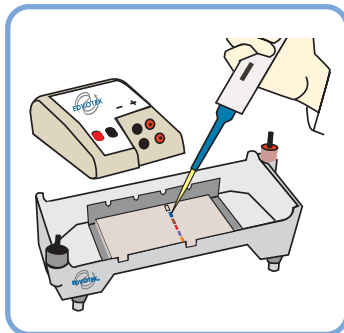

LOAD THE SAMPLES

For either QuickStrip™ or individual microtest tube format, samples should be loaded into the wells of the gel in consecutive order.

Load the DNA samples in tubes A - F into the wells in consecutive order. The amount of sample that should be loaded is 35-38 μ l.

| Lane | Label | Sample |
|------|-------|------------------|
| 1 | A | Orange |
| 2 | B | Purple |
| 3 | C | Red |
| 4 | D | Blue 1 |
| 5 | E | Dye Mixture |
| 6 | F | Blue Dye Mixture |



Duplication of this document, in conjunction with use of accompanying reagents, is permitted for classroom/ laboratory use only. This document, or any part, may not be reproduced or distributed for any other purpose without the written consent of EDVOTEK, Inc. Copyright © 1994, 1997, 1998, 1999, 2003 EDVOTEK, Inc., all rights reserved. EVT 008114K

Conducting Agarose Gel Electrophoresis

RUNNING THE GEL

- After the samples are loaded, carefully snap the cover down onto the electrode terminals.

Make sure that the negative and positive color-coded indicators on the cover and apparatus chamber are properly oriented.
- Insert the plug of the black wire into the black input of the power source (negative input). Insert the plug of the red wire into the red input of the power source (positive input).
- Set the power source at the required voltage and conduct electrophoresis for the length of time determined by your instructor. General guidelines are presented in Table C.
- Check to see that current is flowing properly - you should see bubbles forming on the two platinum electrodes.
- After approximately 10 minutes, you will begin to see separation of the colored dyes.

Table C Time and Voltage

Electrophoresis of Dyes

| Volts | Recommended Time | |
|-------|------------------|---------|
| | Minimum | Maximum |
| 50 | 60 min | 2 hrs |
| 70* | 30 min | 50 min |
| 125 | 20 min | 30 min |

*The EDVOTEK Model #M6 should not be run at higher than 70 volts.

- After the electrophoresis is completed, turn off the power, unplug the power source, disconnect the leads and remove the cover.

- Document the gel results.

A variety of documentation methods can be used, including drawing a picture of the gel, taking a photograph, or scanning an image of the gel on a flatbed scanner.

Staining is not required for Experiment # 101, but results must be analyzed upon completion of the electrophoretic separation. Because dye molecules are extremely small they will diffuse out of the gel. Thus, the gel cannot be saved.

Experiment Results and Study Questions

EXPERIMENT RESULTS - LABORATORY NOTEBOOK RECORDINGS:

Address and record the following in your laboratory notebook or on a separate worksheet.

Before starting the experiment:

- Write a hypothesis that reflects the experiment.
- Predict experimental outcomes.

During the Experiment:

- Record (draw) your observations, or photograph the results.

Following the Experiment:

- Formulate an explanation from the results.
- Determine what could be changed in the experiment if the experiment were repeated.
- Write a hypothesis that would reflect this change.

STUDY QUESTIONS

Answer the following study questions in your laboratory notebook or on a separate worksheet.

1. On what basis does agarose gel electrophoresis separate molecules?
2. Explain migration according to charge.
3. What conclusion can be drawn from the results of sample F?
4. Why is glycerol added to the solutions before they are loaded into the wells?
5. What would happen if distilled water were substituted for buffer in either the chamber solution or the gel solution?



Duplication of this document, in conjunction with use of accompanying reagents, is permitted for classroom/ laboratory use only. This document, or any part, may not be reproduced or distributed for any other purpose without the written consent of EDVOTEK, Inc. Copyright © 1994, 1997, 1998, 1999, 2003 EDVOTEK, Inc., all rights reserved. EVT 008114K

| | | | |
|--|---------|---|-------------------------|
|  Material Safety Data Sheet May be used to comply with OSHA's Hazard Communication Standard. 29 CFR 1910.1200 Standard must be consulted for specific requirements. | | | |
| IDENTITY (As Used on Label and List) Orange G | | Note: Blank spaces are not permitted. If any item is not applicable, or no information is available, the space must be marked to indicate that. | |
| Section I | | | |
| Manufacturer's Name EDVOTEK, Inc. | | Emergency Telephone Number (301) 251-5990 | |
| Address (Number, Street, City, State, Zip Code) 14676 Rothgeb Drive Rockville, MD 20850 | | Telephone Number for information (301) 251-5990 | |
| | | Date Prepared 07/01/03 | |
| | | Signature of Preparer (optional) | |
| Section II - Hazardous Ingredients/Identify Information | | | |
| Hazardous Components [Specific Chemical Identity; Common Name(s)] OSHA PEL ACGIH TLV Other Limits Recommended % (Optional) | | | |
| This product contains no hazardous materials as defined by the OSHA Hazard Communication Standard. CAS # 1936-15-8 | | | |
| Section III - Physical/Chemical Characteristics | | | |
| Boiling Point | No data | Specific Gravity (H ₂ O = 1) | No data |
| Vapor Pressure (mm Hg.) | No data | Melting Point | N/A |
| Vapor Density (AIR = 1) | No data | Evaporation Rate (Butyl Acetate = 1) | No data |
| Solubility in Water Soluble | | | |
| Appearance and Odor yellow-orange color, liquid, no odor | | | |
| Section IV - Physical/Chemical Characteristics | | | |
| Flash Point (Method Used) | No data | Flammable Limits | LEL No data UEL No data |
| Extinguishing Media N/A | | | |
| Special Fire Fighting Procedures N/A | | | |
| Unusual Fire and Explosion Hazards None | | | |

| | | | |
|--|----------------------|----------------|---------------------|
| Section V - Reactivity Data | | | |
| Stability | Unstable | | Conditions to Avoid |
| | Stable | X | Unknown |
| Incompatibility None | | | |
| Hazardous Decomposition or Byproducts Sulfur oxides and bromides | | | |
| Hazardous Polymerization | May Occur | | Conditions to Avoid |
| | Will Not Occur | X | None |
| Section VI - Health Hazard Data | | | |
| Route(s) of Entry: Inhalation? No Skin? Yes Ingestion? Yes | | | |
| Health Hazards (Acute and Chronic) Acute eye contact: may cause irritation | | | |
| Carcinogenicity: NTP? IARC Monographs? OSHA Regulation? | | | |
| None No data No data No | | | |
| Signs and Symptoms of Exposure May cause skin or eye irritation | | | |
| Medical Conditions Generally Aggravated by Exposure None reported | | | |
| Emergency First Aid Procedures Rinse contacted areas with copious amounts of water | | | |
| Section VII - Precautions for Safe Handling and Use | | | |
| Steps to be Taken in case Material is Released for Spilled | | | |
| Wear eye and skin protection and mop/wipe spill area. Rinse with water. | | | |
| Waste Disposal Method | | | |
| Can be disposed in the trash or down the sink | | | |
| Precautions to be Taken in Handling and Storing | | | |
| Avoid eye and skin contact | | | |
| Other Precautions | | | |
| None | | | |
| Section VIII - Control Measures | | | |
| Respiratory Protection (Specify Type) NIOSH/MSHA - approved respirator | | | |
| Ventilation | Local Exhaust | No | Special None |
| | Mechanical (General) | No | Other None |
| Protective Gloves | Yes | Eye Protection | Splash prof goggles |
| Other Protective Clothing or Equipment None required | | | |
| Work/Hygienic Practices Avoid eye and skin contact | | | |

| | | | |
|--|---------|---|-------------------------|
|  Material Safety Data Sheet May be used to comply with OSHA's Hazard Communication Standard. 29 CFR 1910.1200 Standard must be consulted for specific requirements. | | | |
| IDENTITY (As Used on Label and List) Bromophenol Blue | | Note: Blank spaces are not permitted. If any item is not applicable, or no information is available, the space must be marked to indicate that. | |
| Section I | | | |
| Manufacturer's Name EDVOTEK, Inc. | | Emergency Telephone Number (301) 251-5990 | |
| Address (Number, Street, City, State, Zip Code) 14676 Rothgeb Drive Rockville, MD 20850 | | Telephone Number for information (301) 251-5990 | |
| | | Date Prepared 07/01/03 | |
| | | Signature of Preparer (optional) | |
| Section II - Hazardous Ingredients/Identify Information | | | |
| Hazardous Components [Specific Chemical Identity; Common Name(s)] OSHA PEL ACGIH TLV Other Limits Recommended % (Optional) | | | |
| This product contains no hazardous materials as defined by the OSHA Hazard Communication Standard. CAS # 62625-28-9 | | | |
| Section III - Physical/Chemical Characteristics | | | |
| Boiling Point | No data | Specific Gravity (H ₂ O = 1) | No data |
| Vapor Pressure (mm Hg.) | No data | Melting Point | N/A |
| Vapor Density (AIR = 1) | No data | Evaporation Rate (Butyl Acetate = 1) | No data |
| Solubility in Water Soluble | | | |
| Appearance and Odor Blue color, liquid, no odor | | | |
| Section IV - Physical/Chemical Characteristics | | | |
| Flash Point (Method Used) | No data | Flammable Limits | LEL No data UEL No data |
| Extinguishing Media N/A | | | |
| Special Fire Fighting Procedures N/A | | | |
| Unusual Fire and Explosion Hazards None | | | |

| | | | |
|--|----------------------|----------------|---------------------|
| Section V - Reactivity Data | | | |
| Stability | Unstable | | Conditions to Avoid |
| | Stable | X | Unknown |
| Incompatibility None | | | |
| Hazardous Decomposition or Byproducts Sulfur oxides and bromides | | | |
| Hazardous Polymerization | May Occur | | Conditions to Avoid |
| | Will Not Occur | X | None |
| Section VI - Health Hazard Data | | | |
| Route(s) of Entry: Inhalation? No Skin? Yes Ingestion? Yes | | | |
| Health Hazards (Acute and Chronic) Acute eye contact: may cause irritation | | | |
| Carcinogenicity: NTP? IARC Monographs? OSHA Regulation? | | | |
| None No data No data No | | | |
| Signs and Symptoms of Exposure May cause skin or eye irritation | | | |
| Medical Conditions Generally Aggravated by Exposure None reported | | | |
| Emergency First Aid Procedures Rinse contacted areas with copious amounts of water | | | |
| Section VII - Precautions for Safe Handling and Use | | | |
| Steps to be Taken in case Material is Released for Spilled | | | |
| Wear eye and skin protection and mop/wipe spill area. Rinse with water. | | | |
| Waste Disposal Method | | | |
| Can be disposed in the trash or down the sink | | | |
| Precautions to be Taken in Handling and Storing | | | |
| Avoid eye and skin contact | | | |
| Other Precautions | | | |
| None | | | |
| Section VIII - Control Measures | | | |
| Respiratory Protection (Specify Type) NIOSH/MSHA - approved respirator | | | |
| Ventilation | Local Exhaust | No | Special None |
| | Mechanical (General) | No | Other None |
| Protective Gloves | Yes | Eye Protection | Splash prof goggles |
| Other Protective Clothing or Equipment None required | | | |
| Work/Hygienic Practices Avoid eye and skin contact | | | |

| | | | |
|--|---------|---|---------|
|  Material Safety Data Sheet May be used to comply with OSHA's Hazard Communication Standard. 29 CFR 1910.1200 Standard must be consulted for specific requirements. | | | |
| IDENTITY (As Used on Label and List) Phenol Red | | | |
| Note: Blank spaces are not permitted. If any item is not applicable, or no information is available, the space must be marked to indicate that. | | | |
| Section I Manufacturer's Name EDVOTEK, Inc. Address (Number, Street, City, State, Zip Code) 14676 Rothgeb Drive Rockville, MD 20850 | | | |
| Emergency Telephone Number (301) 251-5990 | | | |
| Telephone Number for information (301) 251-5990 | | | |
| Date Prepared 07/01/03 | | | |
| Signature of Preparer (optional) | | | |
| Section II - Hazardous Ingredients/Identify Information Hazardous Components [Specific Chemical Identity; Common Name(s)] OSHA PEL ACGIH TLV Other Limits Recommended % (Optional) This product contains no hazardous materials as defined by the OSHA Hazard Communication Standard. CAS # 7114-03-6 | | | |
| Section III - Physical/Chemical Characteristics | | | |
| Boiling Point | No data | Specific Gravity (H ₂ O = 1) | No data |
| Vapor Pressure (mm Hg.) | No data | Melting Point | N/A |
| Vapor Density (AIR = 1) | No data | Evaporation Rate (Butyl Acetate = 1) | No data |
| Solubility in Water | | Soluble | |
| Appearance and Odor | | Red color, liquid, no odor | |
| Section IV - Physical/Chemical Characteristics | | Flash Point (Method Used) No data Flammable Limits LEL No data UEL No data Extinguishing Media N/A Special Fire Fighting Procedures N/A Unusual Fire and Explosion Hazards None | |

| | | | |
|--|----------------------|----------------|---------------------|
| Section V - Reactivity Data | | | |
| Stability | Unstable | | Conditions to Avoid |
| | Stable | X | Unknown |
| Incompatibility | | | |
| None | | | |
| Hazardous Decomposition or Byproducts | | | |
| Sulfur oxides and bromides | | | |
| Hazardous Polymerization | May Occur | | Conditions to Avoid |
| | Will Not Occur | X | None |
| Section VI - Health Hazard Data | | | |
| Route(s) of Entry: Inhalation? No Skin? Yes Ingestion? Yes | | | |
| Health Hazards (Acute and Chronic) Acute eye contact: may cause irritation | | | |
| Carcinogenicity: NTP? IARC Monographs? OSHA Regulation? | | | |
| None No data No data No | | | |
| Signs and Symptoms of Exposure May cause skin or eye irritation | | | |
| Medical Conditions Generally Aggravated by Exposure None reported | | | |
| Emergency First Aid Procedures | | | |
| Rinse contacted areas with copious amounts of water | | | |
| Section VII - Precautions for Safe Handling and Use | | | |
| Steps to be Taken in case Material is Released for Spilled | | | |
| Wear eye and skin protection and mop/wipe spill area. Rinse with water. | | | |
| Waste Disposal Method | | | |
| Can be disposed in the trash or down the sink | | | |
| Precautions to be Taken in Handling and Storing | | | |
| Avoid eye and skin contact | | | |
| Other Precautions | | | |
| None | | | |
| Section VIII - Control Measures | | | |
| Respiratory Protection (Specify Type) NIOSH/MSHA - approved respirator | | | |
| Ventilation | Local Exhaust | No | Special None |
| | Mechanical (General) | No | Other None |
| Protective Gloves | Yes | Eye Protection | Splash prof goggles |
| Other Protective Clothing or Equipment | | | |
| None required | | | |
| Work/Hygienic Practices | | | |
| Avoid eye and skin contact | | | |

| | | | |
|--|---------|---|---------|
|  Material Safety Data Sheet May be used to comply with OSHA's Hazard Communication Standard. 29 CFR 1910.1200 Standard must be consulted for specific requirements. | | | |
| IDENTITY (As Used on Label and List) Xylene Cyanol | | | |
| Note: Blank spaces are not permitted. If any item is not applicable, or no information is available, the space must be marked to indicate that. | | | |
| Section I Manufacturer's Name EDVOTEK, Inc. Address (Number, Street, City, State, Zip Code) 14676 Rothgeb Drive Rockville, MD 20850 | | | |
| Emergency Telephone Number (301) 251-5990 | | | |
| Telephone Number for information (301) 251-5990 | | | |
| Date Prepared 07/01/03 | | | |
| Signature of Preparer (optional) | | | |
| Section II - Hazardous Ingredients/Identify Information Hazardous Components [Specific Chemical Identity; Common Name(s)] OSHA PEL ACGIH TLV Other Limits Recommended % (Optional) This product contains no hazardous materials as defined by the OSHA Hazard Communication Standard. CAS # 2650-17-1 | | | |
| Section III - Physical/Chemical Characteristics | | | |
| Boiling Point | No data | Specific Gravity (H ₂ O = 1) | No data |
| Vapor Pressure (mm Hg.) | No data | Melting Point | N/A |
| Vapor Density (AIR = 1) | No data | Evaporation Rate (Butyl Acetate = 1) | No data |
| Solubility in Water | | Soluble | |
| Appearance and Odor | | _____ color, liquid, no odor | |
| Section IV - Physical/Chemical Characteristics | | Flash Point (Method Used) No data Flammable Limits LEL No data UEL No data Extinguishing Media N/A Special Fire Fighting Procedures N/A Unusual Fire and Explosion Hazards None | |

| | | | |
|--|----------------------|----------------|---------------------|
| Section V - Reactivity Data | | | |
| Stability | Unstable | | Conditions to Avoid |
| | Stable | X | Unknown |
| Incompatibility | | | |
| None | | | |
| Hazardous Decomposition or Byproducts | | | |
| Sulfur oxides and bromides | | | |
| Hazardous Polymerization | May Occur | | Conditions to Avoid |
| | Will Not Occur | X | None |
| Section VI - Health Hazard Data | | | |
| Route(s) of Entry: Inhalation? No Skin? Yes Ingestion? Yes | | | |
| Health Hazards (Acute and Chronic) Acute eye contact: may cause irritation | | | |
| Carcinogenicity: NTP? IARC Monographs? OSHA Regulation? | | | |
| None No data No data No | | | |
| Signs and Symptoms of Exposure May cause skin or eye irritation | | | |
| Medical Conditions Generally Aggravated by Exposure None reported | | | |
| Emergency First Aid Procedures | | | |
| Rinse contacted areas with copious amounts of water | | | |
| Section VII - Precautions for Safe Handling and Use | | | |
| Steps to be Taken in case Material is Released for Spilled | | | |
| Wear eye and skin protection and mop/wipe spill area. Rinse with water. | | | |
| Waste Disposal Method | | | |
| Can be disposed in the trash or down the sink | | | |
| Precautions to be Taken in Handling and Storing | | | |
| Avoid eye and skin contact | | | |
| Other Precautions | | | |
| None | | | |
| Section VIII - Control Measures | | | |
| Respiratory Protection (Specify Type) NIOSH/MSHA - approved respirator | | | |
| Ventilation | Local Exhaust | No | Special None |
| | Mechanical (General) | No | Other None |
| Protective Gloves | Yes | Eye Protection | Splash prof goggles |
| Other Protective Clothing or Equipment | | | |
| None required | | | |
| Work/Hygienic Practices | | | |
| Avoid eye and skin contact | | | |

| | | | |
|--|---------|---|-------------------------|
|  Material Safety Data Sheet May be used to comply with OSHA's Hazard Communication Standard. 29 CFR 1910.1200 Standard must be consulted for specific requirements. | | | |
| IDENTITY (As Used on Label and List) Methylene Blue | | | |
| Note: Blank spaces are not permitted. If any item is not applicable, or no information is available, the space must be marked to indicate that. | | | |
| Section I Manufacturer's Name EDVOTEK, Inc. Address (Number, Street, City, State, Zip Code) 14676 Rothgeb Drive Rockville, MD 20850 | | | |
| Emergency Telephone Number (301) 251-5990 | | | |
| Telephone Number for information (301) 251-5990 | | | |
| Date Prepared 07/01/03 | | | |
| Signature of Preparer (optional) | | | |
| Section II - Hazardous Ingredients/Identify Information Hazardous Components [Specific Chemical Identity; Common Name(s)] OSHA PEL ACGIH TLV Other Limits Recommended % (Optional) This product contains no hazardous materials as defined by the OSHA Hazard Communication Standard. CAS # 7220-79-3 | | | |
| Section III - Physical/Chemical Characteristics | | | |
| Boiling Point | No data | Specific Gravity (H ₂ O = 1) | No data |
| Vapor Pressure (mm Hg.) | No data | Melting Point | N/A |
| Vapor Density (AIR = 1) | No data | Evaporation Rate (Butyl Acetate = 1) | No data |
| Solubility in Water | | Soluble | |
| Appearance and Odor | | Blue color, liquid, no odor | |
| Section IV - Physical/Chemical Characteristics | | | |
| Flash Point (Method Used) | No data | Flammable Limits | LEL No data UEL No data |
| Extinguishing Media | | N/A | |
| Special Fire Fighting Procedures | | N/A | |
| Unusual Fire and Explosion Hazards | | None | |

| | | | |
|--|----------------------|------------------|---------------------|
| Section V - Reactivity Data | | | |
| Stability | Unstable | | Conditions to Avoid |
| | Stable | X | Unknown |
| Incompatibility | | | |
| None | | | |
| Hazardous Decomposition or Byproducts | | | |
| Sulfur oxides and bromides | | | |
| Hazardous Polymerization | May Occur | | Conditions to Avoid |
| | Will Not Occur | X | None |
| Section VI - Health Hazard Data | | | |
| Route(s) of Entry: Inhalation? No Skin? Yes Ingestion? Yes | | | |
| Health Hazards (Acute and Chronic) Acute eye contact: may cause irritation | | | |
| Carcinogenicity: | NTP? | IARC Monographs? | OSHA Regulation? |
| None | No data | No data | No |
| Signs and Symptoms of Exposure | | | |
| May cause skin or eye irritation | | | |
| Medical Conditions Generally Aggravated by Exposure | | | |
| None reported | | | |
| Emergency First Aid Procedures | | | |
| Rinse contacted areas with copious amounts of water | | | |
| Section VII - Precautions for Safe Handling and Use | | | |
| Steps to be Taken in case Material is Released for Spilled | | | |
| Wear eye and skin protection and mop/wipe spill area. Rinse with water. | | | |
| Waste Disposal Method | | | |
| Can be disposed in the trash or down the sink | | | |
| Precautions to be Taken in Handling and Storing | | | |
| Avoid eye and skin contact | | | |
| Other Precautions | | | |
| None | | | |
| Section VIII - Control Measures | | | |
| Respiratory Protection (Specify Type) NIOSH/MSHA - approved respirator | | | |
| Ventilation | Local Exhaust | No | Special None |
| | Mechanical (General) | No | Other None |
| Protective Gloves | Yes | Eye Protection | Splash prof goggles |
| Other Protective Clothing or Equipment | | | |
| None required | | | |
| Work/Hygienic Practices | | | |
| Avoid eye and skin contact | | | |

| | | | |
|--|---------|---|-------------------------|
|  Material Safety Data Sheet May be used to comply with OSHA's Hazard Communication Standard. 29 CFR 1910.1200 Standard must be consulted for specific requirements. | | | |
| IDENTITY (As Used on Label and List) Practice Gel Loading Solution | | | |
| Note: Blank spaces are not permitted. If any item is not applicable, or no information is available, the space must be marked to indicate that. | | | |
| Section I Manufacturer's Name EDVOTEK, Inc. Address (Number, Street, City, State, Zip Code) 14676 Rothgeb Drive Rockville, MD 20850 | | | |
| Emergency Telephone Number (301) 251-5990 | | | |
| Telephone Number for information (301) 251-5990 | | | |
| Date Prepared 07/01/03 | | | |
| Signature of Preparer (optional) | | | |
| Section II - Hazardous Ingredients/Identify Information Hazardous Components [Specific Chemical Identity; Common Name(s)] OSHA PEL ACGIH TLV Other Limits Recommended % (Optional) This product contains no hazardous materials as defined by the OSHA Hazard Communication Standard. | | | |
| Section III - Physical/Chemical Characteristics | | | |
| Boiling Point | No data | Specific Gravity (H ₂ O = 1) | No data |
| Vapor Pressure (mm Hg.) | No data | Melting Point | No data |
| Vapor Density (AIR = 1) | No data | Evaporation Rate (Butyl Acetate = 1) | No data |
| Solubility in Water | | Soluble | |
| Appearance and Odor | | Blue liquid, no odor | |
| Section IV - Physical/Chemical Characteristics | | | |
| Flash Point (Method Used) | No data | Flammable Limits | LEL No data UEL No data |
| Extinguishing Media | | Dry chemical, carbon dioxide, water spray or foam | |
| Special Fire Fighting Procedures | | Use agents suitable for type of surrounding fire. Keep upwind, avoid breathing hazardous sulfur oxides and bromides. Wear SCBA. | |
| Unusual Fire and Explosion Hazards | | Unknown | |

| | | | |
|---|----------------------|------------------|----------------------|
| Section V - Reactivity Data | | | |
| Stability | Unstable | | Conditions to Avoid |
| | Stable | X | None |
| Incompatibility | | | |
| None | | | |
| Hazardous Decomposition or Byproducts | | | |
| Sulfur oxides, and bromides | | | |
| Hazardous Polymerization | May Occur | | Conditions to Avoid |
| | Will Not Occur | X | None |
| Section VI - Health Hazard Data | | | |
| Route(s) of Entry: Inhalation? Yes Skin? Yes Ingestion? Yes | | | |
| Health Hazards (Acute and Chronic) Acute eye contact: May cause irritation. No data available for other routes. | | | |
| Carcinogenicity: | NTP? | IARC Monographs? | OSHA Regulation? |
| No data available | | | |
| Signs and Symptoms of Exposure | | | |
| May cause skin or eye irritation | | | |
| Medical Conditions Generally Aggravated by Exposure | | | |
| None reported | | | |
| Emergency First Aid Procedures | | | |
| Treat symptomatically and supportively. Rinse contacted area with copious amounts of water. | | | |
| Section VII - Precautions for Safe Handling and Use | | | |
| Steps to be Taken in case Material is Released for Spilled | | | |
| Wear eye and skin protection and mop spill area. Rinse with water. | | | |
| Waste Disposal Method | | | |
| Observe all federal, state, and local regulations. | | | |
| Precautions to be Taken in Handling and Storing | | | |
| Avoid eye and skin contact. | | | |
| Other Precautions | | | |
| None | | | |
| Section VIII - Control Measures | | | |
| Respiratory Protection (Specify Type) | | | |
| Ventilation | Local Exhaust | Yes | Special None |
| | Mechanical (General) | Yes | Other None |
| Protective Gloves | Yes | Eye Protection | Splash proof goggles |
| Other Protective Clothing or Equipment | | | |
| None required | | | |
| Work/Hygienic Practices | | | |
| Avoid eye and skin contact | | | |

| | | | | | | | | | | | | | | | | | | | | | |
|---|-----------------------|---|---------|---|---------|-------------------------|---------|---------------|---------|-------------------------|---------|--------------------------------------|---------|---------------------|------------------|--|--|---------------------|-----------------------|--|--|
|  Material Safety Data Sheet May be used to comply with OSHA's Hazard Communication Standard. 29 CFR 1910.1200 Standard must be consulted for specific requirements. | | | | | | | | | | | | | | | | | | | | | |
| IDENTITY (As Used on Label and List) Agarose | | | | | | | | | | | | | | | | | | | | | |
| Note: Blank spaces are not permitted. If any item is not applicable, or no information is available, the space must be marked to indicate that. | | | | | | | | | | | | | | | | | | | | | |
| Section I Manufacturer's Name EDVOTEK, Inc. Address (Number, Street, City, State, Zip Code) 14676 Rothgeb Drive Rockville, MD 20850 | | | | | | | | | | | | | | | | | | | | | |
| Emergency Telephone Number (301) 251-5990 Telephone Number for information (301) 251-5990 Date Prepared 07/01/03 Signature of Preparer (optional) | | | | | | | | | | | | | | | | | | | | | |
| Section II - Hazardous Ingredients/Identify Information Hazardous Components [Specific Chemical Identity; Common Name(s)] OSHA PEL ACGIH TLV Other Limits Recommended % (Optional) This product contains no hazardous materials as defined by the OSHA Hazard Communication Standard. CAS #9012-36-6 | | | | | | | | | | | | | | | | | | | | | |
| Section III - Physical/Chemical Characteristics <table border="1"> <tr> <td>Boiling Point For 1% solution</td> <td>194° F</td> <td>Specific Gravity (H₂O = 1)</td> <td>No data</td> </tr> <tr> <td>Vapor Pressure (mm Hg.)</td> <td>No data</td> <td>Melting Point</td> <td>No data</td> </tr> <tr> <td>Vapor Density (AIR = 1)</td> <td>No data</td> <td>Evaporation Rate (Butyl Acetate = 1)</td> <td>No data</td> </tr> <tr> <td>Solubility in Water</td> <td colspan="3">Insoluble - cold</td> </tr> <tr> <td>Appearance and Odor</td> <td colspan="3">White powder, no odor</td> </tr> </table> | | Boiling Point For 1% solution | 194° F | Specific Gravity (H ₂ O = 1) | No data | Vapor Pressure (mm Hg.) | No data | Melting Point | No data | Vapor Density (AIR = 1) | No data | Evaporation Rate (Butyl Acetate = 1) | No data | Solubility in Water | Insoluble - cold | | | Appearance and Odor | White powder, no odor | | |
| Boiling Point For 1% solution | 194° F | Specific Gravity (H ₂ O = 1) | No data | | | | | | | | | | | | | | | | | | |
| Vapor Pressure (mm Hg.) | No data | Melting Point | No data | | | | | | | | | | | | | | | | | | |
| Vapor Density (AIR = 1) | No data | Evaporation Rate (Butyl Acetate = 1) | No data | | | | | | | | | | | | | | | | | | |
| Solubility in Water | Insoluble - cold | | | | | | | | | | | | | | | | | | | | |
| Appearance and Odor | White powder, no odor | | | | | | | | | | | | | | | | | | | | |
| Section IV - Physical/Chemical Characteristics N.D. = No data Flash Point (Method Used) No data Flammable Limits LEL N.D. UEL N.D. Extinguishing Media Water spray, dry chemical, carbon dioxide, halon or standard foam Special Fire Fighting Procedures Possible fire hazard when exposed to heat or flame Unusual Fire and Explosion Hazards None | | | | | | | | | | | | | | | | | | | | | |

| | | | | | | | | | |
|---|--|---------|--|-------------|---------------|---------|--|--|-------|
| Section V - Reactivity Data Stability Unstable Stable X Conditions to Avoid None Incompatibility No data available Hazardous Decomposition or Byproducts | | | | | | | | | |
| Hazardous Polymerization May Occur Will Not Occur X Conditions to Avoid None | | | | | | | | | |
| Section VI - Health Hazard Data Route(s) of Entry: Inhalation? Yes Skin? Yes Ingestion? Yes Health Hazards (Acute and Chronic) Inhalation: No data available Ingestion: Large amounts may cause diarrhea Carcinogenicity: NTP? IARC Monographs? OSHA Regulation? | | | | | | | | | |
| Signs and Symptoms of Exposure No data available Medical Conditions Generally Aggravated by Exposure No data available Emergency First Aid Procedures Treat symptomatically and supportively | | | | | | | | | |
| Section VII - Precautions for Safe Handling and Use Steps to be Taken in case Material is Released for Spilled Sweep up and place in suitable container for disposal Waste Disposal Method Normal solid waste disposal Precautions to be Taken in Handling and Storing None Other Precautions None | | | | | | | | | |
| Section VIII - Control Measures Respiratory Protection (Specify Type) Chemical cartridge respirator with full facepiece. <table border="1"> <tr> <td>Ventilation</td> <td>Local Exhaust</td> <td>Special</td> </tr> <tr> <td></td> <td>Mechanical (General) Gen. dilution ventilation</td> <td>Other</td> </tr> </table> Protective Gloves Yes Eye Protection Splash proof goggles Other Protective Clothing or Equipment Impervious clothing to prevent skin contact Work/Hygienic Practices None | | | | Ventilation | Local Exhaust | Special | | Mechanical (General) Gen. dilution ventilation | Other |
| Ventilation | Local Exhaust | Special | | | | | | | |
| | Mechanical (General) Gen. dilution ventilation | Other | | | | | | | |

| | | | | | | | | | | | | | | | | | | | | | |
|--|------------------------------------|---|---------|---|---------|-------------------------|---------|---------------|---------|-------------------------|---------|--------------------------------------|---------|---------------------|---------------------------------|--|--|---------------------|------------------------------------|--|--|
|  Material Safety Data Sheet May be used to comply with OSHA's Hazard Communication Standard. 29 CFR 1910.1200 Standard must be consulted for specific requirements. | | | | | | | | | | | | | | | | | | | | | |
| IDENTITY (As Used on Label and List) 50x Electrophoresis Buffer | | | | | | | | | | | | | | | | | | | | | |
| Note: Blank spaces are not permitted. If any item is not applicable, or no information is available, the space must be marked to indicate that. | | | | | | | | | | | | | | | | | | | | | |
| Section I Manufacturer's Name EDVOTEK, Inc. Address (Number, Street, City, State, Zip Code) 14676 Rothgeb Drive Rockville, MD 20850 | | | | | | | | | | | | | | | | | | | | | |
| Emergency Telephone Number (301) 251-5990 Telephone Number for information (301) 251-5990 Date Prepared 07/01/03 Signature of Preparer (optional) | | | | | | | | | | | | | | | | | | | | | |
| Section II - Hazardous Ingredients/Identify Information Hazardous Components [Specific Chemical Identity; Common Name(s)] OSHA PEL ACGIH TLV Other Limits Recommended % (Optional) This product contains no hazardous materials as defined by the OSHA Hazard Communication Standard. | | | | | | | | | | | | | | | | | | | | | |
| Section III - Physical/Chemical Characteristics <table border="1"> <tr> <td>Boiling Point</td> <td>No data</td> <td>Specific Gravity (H₂O = 1)</td> <td>No data</td> </tr> <tr> <td>Vapor Pressure (mm Hg.)</td> <td>No data</td> <td>Melting Point</td> <td>No data</td> </tr> <tr> <td>Vapor Density (AIR = 1)</td> <td>No data</td> <td>Evaporation Rate (Butyl Acetate = 1)</td> <td>No data</td> </tr> <tr> <td>Solubility in Water</td> <td colspan="3">Appreciable, (greater than 10%)</td> </tr> <tr> <td>Appearance and Odor</td> <td colspan="3">Clear, liquid, slight vinegar odor</td> </tr> </table> | | Boiling Point | No data | Specific Gravity (H ₂ O = 1) | No data | Vapor Pressure (mm Hg.) | No data | Melting Point | No data | Vapor Density (AIR = 1) | No data | Evaporation Rate (Butyl Acetate = 1) | No data | Solubility in Water | Appreciable, (greater than 10%) | | | Appearance and Odor | Clear, liquid, slight vinegar odor | | |
| Boiling Point | No data | Specific Gravity (H ₂ O = 1) | No data | | | | | | | | | | | | | | | | | | |
| Vapor Pressure (mm Hg.) | No data | Melting Point | No data | | | | | | | | | | | | | | | | | | |
| Vapor Density (AIR = 1) | No data | Evaporation Rate (Butyl Acetate = 1) | No data | | | | | | | | | | | | | | | | | | |
| Solubility in Water | Appreciable, (greater than 10%) | | | | | | | | | | | | | | | | | | | | |
| Appearance and Odor | Clear, liquid, slight vinegar odor | | | | | | | | | | | | | | | | | | | | |
| Section IV - Physical/Chemical Characteristics N.D. = No data Flash Point (Method Used) No data Flammable Limits LEL N.D. UEL N.D. Extinguishing Media Use extinguishing media appropriate for surrounding fire. Special Fire Fighting Procedures Wear protective equipment and SCBA with full facepiece operated in positive pressure mode. Unusual Fire and Explosion Hazards None identified | | | | | | | | | | | | | | | | | | | | | |

| | | | | | | | | | | | | | |
|---|----------------------|-----|---------|-------------|---------------|-----|---------|------|--|----------------------|-----|-------|------|
| Section V - Reactivity Data Stability Unstable Stable X Conditions to Avoid None Incompatibility Strong oxidizing agents Hazardous Decomposition or Byproducts Carbon monoxide, Carbon dioxide | | | | | | | | | | | | | |
| Hazardous Polymerization May Occur Will Not Occur X Conditions to Avoid None | | | | | | | | | | | | | |
| Section VI - Health Hazard Data Route(s) of Entry: Inhalation? Yes Skin? Yes Ingestion? Yes Health Hazards (Acute and Chronic) None Carcinogenicity: None identified NTP? IARC Monographs? OSHA Regulation? | | | | | | | | | | | | | |
| Signs and Symptoms of Exposure Irritation to upper respiratory tract, skin, eyes Medical Conditions Generally Aggravated by Exposure None Emergency First Aid Procedures Ingestion: If conscious, give large amounts of water Eyes: Flush with water Inhalation: Move to fresh air Skin: Wash with soap and water | | | | | | | | | | | | | |
| Section VII - Precautions for Safe Handling and Use Steps to be Taken in case Material is Released for Spilled Wear suitable protective clothing. Mop up spill and rinse with water, or collect in absorbent material and dispose of the absorbent material. Waste Disposal Method Dispose in accordance with all applicable federal, state, and local environmental regulations. Precautions to be Taken in Handling and Storing Avoid eye and skin contact. Other Precautions None | | | | | | | | | | | | | |
| Section VIII - Control Measures Respiratory Protection (Specify Type) <table border="1"> <tr> <td>Ventilation</td> <td>Local Exhaust</td> <td>Yes</td> <td>Special</td> <td>None</td> </tr> <tr> <td></td> <td>Mechanical (General)</td> <td>Yes</td> <td>Other</td> <td>None</td> </tr> </table> Protective Gloves Yes Eye Protection Safety goggles Other Protective Clothing or Equipment None Work/Hygienic Practices None | | | | Ventilation | Local Exhaust | Yes | Special | None | | Mechanical (General) | Yes | Other | None |
| Ventilation | Local Exhaust | Yes | Special | None | | | | | | | | | |
| | Mechanical (General) | Yes | Other | None | | | | | | | | | |