

MATH 211 FINAL EXAM REVIEW PROBLEMS with ANSWERS

1. $32 \div 4$ in the sharing interpretation of division, base ten pieces:



Share among 4 groups – there are 8 in each group so $32 \div 4 = 8$.

2. $32 \div 4$ in the measurement interpretation of division, base ten pieces

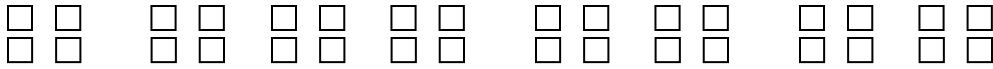

Make groups of size 4 – there are 8 groups so $32 \div 4 = 8$.

3. Write a short and simple story problem for each:

a. Illustrating $18 \div 6$ for the sharing concept of division.

I have 18 apples and want to share them among 6 friends. How many apples does each friend get?

b. Illustrating $18 \div 6$ for the measurement concept of division.

I have 18 apples and I want to put them into bags with 6 in each bag. How many bags do I need?

c. Illustrating $12 - 7$ for the take away concept of subtraction

I have 12 apples and my brother takes 7 apples. How many do I have left?

d. Illustrating $12 - 7$ for the comparison concept of subtraction

I have 12 apples and my brother has 7 apples. How many more apples do I have?

e. Illustrating $12 - 7$ for the missing addend concept of subtraction

I have 7 apples, but I need 12 to make a pie. How many more apples do I need?

4. The number $2^4 \times 3^3 \times 5^2 \times 7^1$ has exactly this many different factors:

$$(4+1) \times (3+1) \times (2+1) \times (1+1) = 120$$

5. The number $2^4 \times 3^3 \times 5^2 \times 7^1$ has exactly this many different PRIME factors:

4 (the prime factors are 2, 3, 5 and 7)

6. The number 354,109,373,276,4x0 will be divisible by 6 if x is replaced by _____?

0 or 3 or 6 or 9

7. The Uris satellite circles the earth every 308 hours. The Arub satellite circles the earth every 660 hours. If both satellites were above Monroe, Louisiana at 7 AM on April 12, the earliest time they will both again be above Monroe is in this many hours:

$$\text{LCM}(308,660) = 4620 = 2 \times 2 \times 3 \times 5 \times 7 \times 11 \text{ hours}$$

8. Which one of the following pairs of numbers is relatively prime?

(10, 20), (23, 46), (16, 30), (15, 42), (32, 125)

GCF(32,125)=1 so (32,125) are relatively prime

9. For this problem: Choose all, if any, that are correct.
The number 354,109,373,286,460 is divisible by: 2, 3, 4, 5, 6, 9, 10, 11?

It is divisible by 2,4,5,10,11

10. Find the LCM (1125, 70) using any method (no calculator).

LCM(1125,70) = $2 \times 3^2 \times 5^3 \times 7 = 15750$

11. Find the GCF (1125, 70) using any method (no calculator).

GCB(1125,70) = 5

12. What is the greatest prime that must be checked to determine if 179 is prime or composite?

13: The square root of 179 is ~ 13.37 so 13 is the largest prime smaller than the square root.

13. GCF(x, y) = 10. LCM(x, y) = 900. $x < y < 150$. Find x and y.

$x = 2 \times 5 \times 3 \times 3 = 90$; $y = 2 \times 5 \times 2 \times 5 = 100$

14. Explain why $2^2 \times 3^2 \times 15$ is not a prime factorization of 540.

15 is not prime

15. If a number is not divisible by 6, can it be divisible by 3? Explain.

Yes - for example 9 is not divisible by 6 but it is divisible by 3.

16. If a number is not divisible by 3, can it be divisible by 6? Explain.

No, 3 divides 6 so if a number is not divisible by 3 it can't be divisible by 6.

17. If a number is not divisible by 6, can it be divisible by 9? Explain.

Yes, for example 9 is not divisible by 6, but it is divisible by 9

18. If a number is not divisible by 2, can it be divisible by 4? Explain.

No, 2 divides 4 so if a number is not divisible by 2 it can't be divisible by 4.

19. If a number is not divisible by 4, can it be divisible by 2? Explain.

Yes, for example 6 is not divisible by 4 but it is divisible by 2.

20. Use black and red tile models with R for red tiles and B for black tiles to show the following: Write clearly and explain your work.

a. $7 + (-5)$ **BBBBBBB**

RRRRR

the 5 black and red cancel leaving 2 black

Answer: 2

b. $4 - 6$ **BBBB**

add two zero pairs to get

BBBBBB

RR

take away 6 black to get

RR Answer: -2

c. $3 - (-1)$

BBB add in a zero

pair to get BBBBR

take out one red

leaving BBBB

Answer: 4

d. 2×-4 **two times,**

put in 4 red tiles:

RRRR RRRR

Answer: -8

e. -2×-4

Start with some zero pairs;
BBBBBBBB
RRRRRRRR
then 2 times take out 4 red
leaving BBBBBBBB
Answer: 8

g. $-9 \div 3$

Put 9 red tiles into 3 groups. How many in each group? 3 red
RRR RRR RRR
Answer -3

f. -2×4

Start with some zero pairs;
BBBBBBBB
RRRRRRRR
then two times take out 4 black leaving
RRRRRRRR
Answer: -8

h. $-9 \div -3$

Put 9 red tiles into groups of 3 red tiles each. How many groups? 3 groups
RRR RRR RRR
Answer: 3

21. Closed or not?

- a. The set of whole numbers for division. **NO (e.g. $3 \div 2$ is not a whole number)**
- b. The set of whole numbers for addition. **YES**
- c. The set of whole numbers for subtraction. **NO (e.g. $2-7$ is not a whole number)**
- d. The set of even whole numbers for multiplication. **YES**
- e. The set of integers for multiplication. **YES**
- f. The set of integers for division. **NO (e.g. $5 \div 2$ is not an integer)**
- g. The set of negative integers for addition. **YES**
- h. The set of positive integers for subtraction. **NO (e.g. $1-3$ is not positive)**
- i. The set of even integers for subtraction. **YES**
- j. The set of odd integers for subtraction. **NO (e.g. $5 - 3$ is not odd)**
- k. The set of $\{0, 1\}$ for addition **NO (e.g. $1 + 1$ is not in the set)**
- l. The set of $\{0, 1\}$ for multiplication **YES**

22. Commutative or not?

- a. The set of whole numbers for division. **NO (e.g. $5 \div 2 \neq 2 \div 5$)**
- b. The set of whole numbers for addition. **YES**
- c. The set of whole numbers for subtraction. **NO (e.g. $5 - 2 \neq 2 - 5$)**
- d. The set of integers for multiplication **YES**
- e. The set of integers for division. **NO (e.g. $5 \div 2 \neq 2 \div 5$)**
- f. The set of negative integers for addition. **YES**
- g. The set of even integers for subtraction. **NO (e.g. $4-2 \neq 2-4$)**
- h. The set $\{0, 1\}$ for addition **YES**
- i. The set $\{0, 1\}$ for multiplication **YES**

23. Associative or not? **$(a+b) + c = a + (b+c)$**

- a. The set of whole numbers for division. **NO (e.g. $(4 \div 2) \div 2 = 1$ but $4 \div (2 \div 2) = 4$)**
- b. The set of whole numbers for addition. **YES**
- c. The set of whole numbers for subtraction. **NO (e.g. $(6-3)-3=0$ but $6-(3-3)=6$)**
- d. The set of integers for multiplication. **YES**
- e. The set of negative integers for addition. **YES**
- f. The set of even integers for subtraction. **NO (e.g. $(6-4)-2 = 0$ but $6-(4-2)=4$)**

24. Identity

- a. What is the identity for whole numbers for addition? For integers? **0**
- b. What is the identity for whole numbers for multiplication? For integers? **1**

25. Distributive

- a. What is the distributive property for whole numbers for multiplication over addition? For integers? For multiplication over subtraction?

multiplication over addition (whole numbers & integers):

$$a \times (b+c) = (a \times b) + (a \times c)$$

multiplication over subtraction (whole numbers & integers):

$$a \times (b-c) = (a \times b) - (a \times c)$$

- b. What is the distributive property for integers for multiplication subtraction?
(see previous problem)

26. Valid or invalid?

All children love to draw.

Cindy is a child.

Therefore, Cindy loves to draw. **VALID**

27. Valid or invalid?

Some educated people are rascals.

Doctors are educated people.

Therefore, doctors are not rascals. **INVALID**

28. List the factors of 12. List the first 4 multiples of 12.

Factors of 12: 1,2,3,4,6,12; first 4 multiples of 12: 12, 24, 36, 48

29. Rewrite each of the following using i) converse, ii) inverse and iii) contrapositive. In each case use a Venn diagram to show whether the new statement is valid or invalid.

- a. If I buy apples then I have fruit to eat.

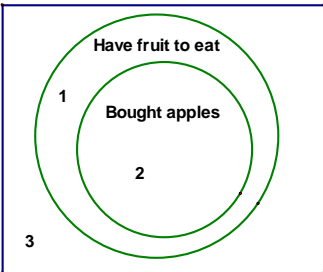
VENN DIAGRAM	CONVERSE: If I have to fruit to eat, then I bought apples.
	<p>Invalid – At #1 I have fruit to eat, but didn't buy apples.</p> <p>INVERSE: If I do not buy apples, then I do not have fruit to eat. INVALID At #1 – I did not buy apples, but still have fruit to eat</p> <p>CONTRAPOSITIVE: If I do not have fruit to eat, then I did not buy apples. VALID If I did not have fruit I must be at #3 which means I did not buy apples.</p>

b. I will wash my dog if it is hot out.

Rewrite as If P then Q: If it is hot out, then I will wash my dog.

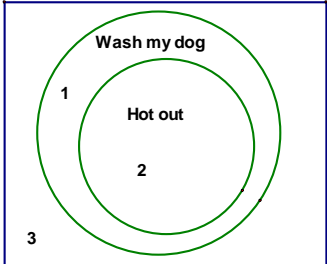
VENN DIAGRAM	CONVERSE: If I wash my dog, then it is hot out. INVALID – at #1 I wash my dog, but it is not hot out.
	<p>INVERSE: If it is not hot out, then I do not wash my dog: INVALID – at #1 it is not hot out, but I still wash my dog.</p> <p>CONTRAPOSITIVE: If I do not wash my dog, then it is not hot out. VALID: If I don't wash my dog, I must be at #3 which means I it is not hot out.</p>

c. I will not take Math 212 in the winter if I don't study for the math 211 final.

Rewrite as IF P THEN Q:

If I don't study for the math 211 final, then I will not take Math 212 in the winter.

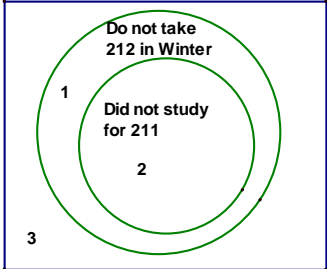
VENN DIAGRAM	CONVERSE: If I don't take Math 212 in the winter, then I didn't study for my 211 final. INVALID: At #1 I do not take 212 in the winter, but I did study for the 211 final.
	<p>INVERSE: If I study for the math 211 final, then I will take math 212 in the winter: INVALID: AT #1 I studied for the 211 final, but still don't take 212 in the winter.</p> <p>CONTRAPOSITIVE: If I take math 212 in the winter, then I studied for the 211 final. VALID: If I take 212 then I must be at #3 in which case I did study for my 211 final.</p>

30. Write 1247_{ten} in expanded form (base 10).
 $(1 \times 10^3) + (2 \times 10^2) + (4 \times 10) + 7$

31. How many units are in 1847_{nine} ?
 $(1 \times 9^3) + (8 \times 9^2) + (4 \times 9) + 7 = 1420$

32. What are the digits in any base b?
0,1,2,...,b-1

33. What are the place values in any base b?
1, b^2 , b^3 , b^4 , ...

34. Sketch the base four number pieces representing this addition, including all regroupings. Show the addition algorithm and record the resulting base four numeral.

$$2311_{\text{four}} + 203_{\text{four}}$$

Answer: 3120_{four} (drawings/algorithm not shown)

35. Sketch the base four number pieces representing this subtraction, including all regroupings. Show the subtraction algorithm and record the resulting base four numeral.

$$222_{\text{four}} - 133_{\text{four}}$$

Answer: 23_{four} (drawings/algorithm not shown)

36. Sketch the base four number pieces representing this multiplication; including all regroupings. Show the multiplication algorithm and record the resulting base four numeral.

$$22_{\text{four}} \times 13_{\text{four}}$$

Answer: 1012_{four} (drawings/algorithm not shown)

37. Select 4 flats, 6 longs, and 2 units from your base ten pieces. Using only these pieces (all of them), and making no exchanges, form a rectangle.

Neatly sketch the rectangle you made, label the edge dimensions and the four partial products and show the final product it represents.

Answer:

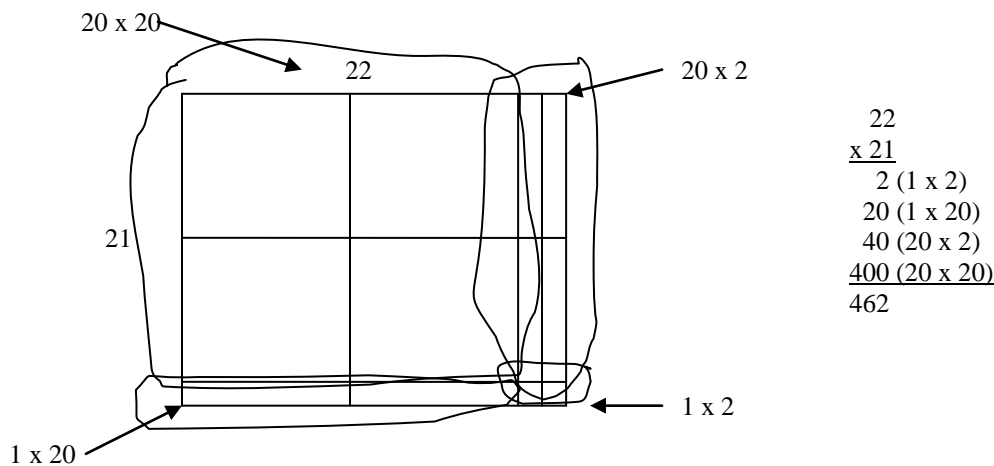

38. Study the pattern below.

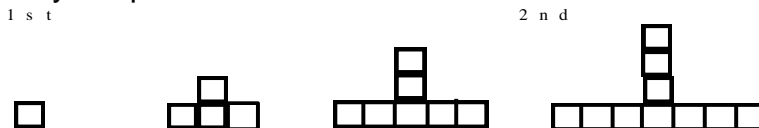

a. If this pattern of tiles continues, draw the 5th figure.

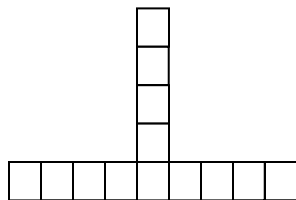

b. If this pattern of tiles is extended to the 150th figure, describe the 150th figure.
The 150th figure will be shaped like an upside down T with $2(150)-1 = 299$ tiles along the bottom and 149 tiles stacked on top of the middle bottom tile.

39. The following sequence of figures begins repeating in the fifth figure.

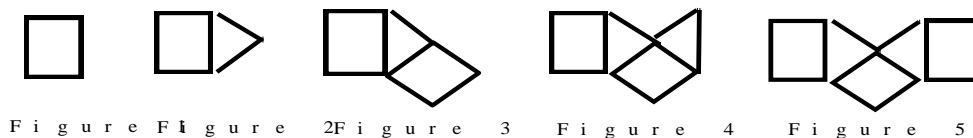

a. Describe and draw the 6th figure.
Add a triangle to the right of the 5th figure

b. How many triangles will there be in the 163rd, the 164th and the 166th figures?
 Explain clearly for credit, a long list of numbers will receive no credit.

Figure 163 will have 81 triangles.

Figure 164 will have 82 triangles.

Figure 166 will have 83 triangles.

40. Arithmetic, geometric and/or finite differences?

Find a pattern in the following sequence and write the next two terms of the sequence.
 2, 5, 8, 11, 14, ... **Answer: 17, 20 (arithmetic)**

41. Arithmetic, geometric and/or finite differences?

Find a pattern in the following sequence and write the next two terms of the sequence.
 2, 5, 12, 24, 42, **Answer: 67, 100 (finite differences)**

42. Arithmetic, geometric and/or finite differences?

Find a pattern in the following sequence and write the next two terms of the sequence.
 3, 12, 48, 192, ... **Answer: 768, 3072 (geometric)**

43. Arithmetic, geometric and/or finite differences (1st or 2nd)?

Find a pattern in the following sequence and write the next two terms of the sequence.
 0, 1, 7, 18, 34, ... **Answer: 55, 81 (finite differences)**

44. Determine the equation of the lines:

a. Between (2,6) and (-3, 4) **Answer: $y = \frac{2}{5}x + \frac{26}{5}$**

b. Between (2,-2) and (-3, 4) **Answer: $y = -\frac{6}{5}x + \frac{2}{5}$**

c. Parallel to $y = 3x - 4$ and through (1, 1) **Answer: $y = 3x - 2$**

d. Perpendicular to $y = 3x - 4$ and through (1, 1) **Answer: $y = -\frac{1}{3}x + \frac{4}{3}$**

45. Simplify or solve

a. $2(x + 3) - 3(x + 2) = 4x$ **Answer: $x = 0$**

b. $-3x < -7x + 14$ **Answer: $x < \frac{14}{4}$**

c. $2(x + 1) - 4(x + 6) + 2(x - 4)$ **Answer: simplifies to -30**

46. Circle to indicate if each statement is true or false. Explain.

Let: Universal Set = {5, 6, 7, 8, 9, 10} A = {5, 6, 9} B = {5, 6} C = {7, 8, 9}

			Explain
a.	F	$A \subseteq B$	9 is in A, but not B
b.	T	$5 \in B$	5 is an element of B
c.	F	$B \subset B$	B is not a PROPER subset of itself
d.	T	$(A \cup C)' = \{10\}$	$A \cup C = \{5, 6, 7, 8, 9\}$ so the complement is just $\{10\}$
e.	F	$B = C$	The sets do not have the same elements.
f.	T	$A \cap B = \{5, 5, 6, 6\}$	But it is more proper just to write $A \cap B = \{5, 6\}$ (without the duplicates)

47. Using your attribute piece set, let Y=Yellow pieces L=large pieces, H=hexagons.

Describe:

a. $Y \cup L$: **All pieces that are large or yellow**

b. $Y \cap L$: **All large, yellow pieces**

c. $(Y \cup H)'$: **Red and blue non-hexagonal pieces**

d. $Y \cap L \cap H$: **The large, yellow hexagon**

e. $(Y \cap L \cap H)'$: **All pieces except the large, yellow hexagon**

f. $(Y \cup L \cup H)'$: **Pieces that are small, red or blue, and non-hexagonal**

g. Describe two sets of attribute pieces, A & B, so that $A \cap B = \emptyset$:

There are many answers – here's one: Let A = yellow pieces, B = blue pieces.

Then A and B have no elements in common so $A \cap B = \emptyset$.

48. Determine the following:

a. $6 \div 2 \times 3 + (4 - 1)^2$ **Answer: 18**

b. $4 \times (3+1) - 2^4$ **Answer: 0**

c. $18 - 3 \times 2 \div 2 + 7$ **Answer: 22**

d. $12 + 7 - 8 \div 4 - 1 \times 7$ **Answer: 10**

49. Use Polya's four steps for problem solving to solve the following:

a. A farmer is building a fence in the shape of a rectangle of dimensions 30 yards by 40 yards. There is a fence post in every corner and one every two yards. How many fence posts will he use?

Answer: He will use 70 fence posts.

b. Jill's mother gave her some money to go shopping. Jill spent half the money on a new pair of shoes, then she spent \$10 on a CD. After that she spent half of what was left over on lunch and had \$12 left. How much money did her mother give her?

Answer: Jill's mother gave her \$68 to go shopping.

50. For each of the following write the set notation that describes the shaded region:

a.

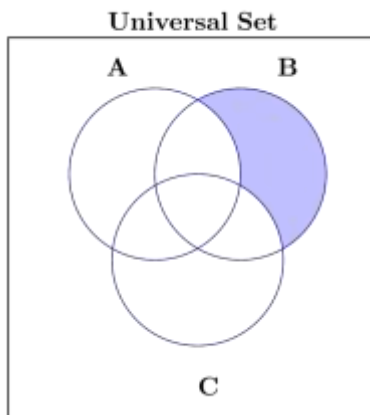

b.

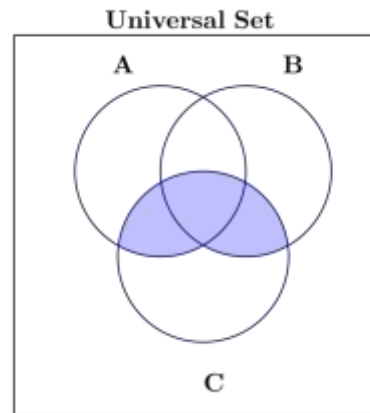

(More than one answer is possible.)

a. $(A \cup C)' \cap B$

b. $(A \cap C) \cup (B \cap C)$ or $(A \cup B) \cap C$